

Incasto a filo o plafone per cartongesso / Plasterboard recessed fixture or surface mounted - MAD designer project



Sistema modulare in estrusione di alluminio per l'installazione a plafone e incasso sia nella versione a scomparsa totale nel cartongesso sia in battuta per tutti i tipi di superficie. Disponibile nelle finiture bianco, nero e alluminio satinato anodizzato, il diffusore in policarbonato è a filo bordo inferiore (non retracts) con emissione non superiore ai 120°. Può essere cablato con strip LED di diversa potenza ed emissione con l'alimentatore in remoto.

Modular, extruded aluminium system for wall/ceiling or trim/trimless recessed installation on all kind of surface.

Available in black, white or satin anodized aluminium finishes, the polycarbonate diffuser flushes with the low profile edge (not retracted), with a light emission not higher than 120°. Connected with a remote power supply, it can be wired with LED strips with different power and meter emission.

Modulsystem aus extrudiertem Aluminium für Decken-, Wand-, oder komplett versenkte Einbaumontage im Gipskarton oder mit Rand für jede Oberfläche. Erhältlich in der Farben schwarz, weiß und eloxiertes satiniertes Aluminium. Der Diffusor aus Polycarbonat ist bündig (nicht zurücktretend) mit Ausstrahlung nicht über 120°. Verkabelung mit LED Bänder von verschiedenen Leistungen per Meter und ferne Verbindung des Vorschaltgerätes.

Profilé modulaire en aluminium extrudé pour l'installation à mur/plafond, ou encastré sans ou avec cadre, pour tout type de surface. Disponible en trois couleurs (blanc, noir et aluminium satiné anodisé), le diffuseur en polycarbonate est au même niveau du bord inférieur du profilé, obtenant une émission lumineuse ne pas supérieure à 120°. Il peut être câblé avec des bandes LED de différente puissance et une émission par mètre, avec une alimentation à distance.

Sistema modular en extrusión de aluminio para la instalación a plafón, y a encastré sea en la versión a ras de las placas de yeso, sea con borde para todo tipo de superficie. Disponible en las terminaciones blanco, negro y aluminio satinado anodizado, el difusor de policarbonato es a ras del borde (no retraído) con un haz de luz no superior a 120°. Pueder ser equipado con strip LED de diferentes potencias y haz de emisión a metro con el transformador remoto.



A. MT1_12, ALREADY MADE FIXTURE



Profilo alluminio 20 x 14,5mm, completo di diffusore, testate di chiusura e 2 staffe di ancoraggio, alimentazione a 24V, 120 LED per metro a 3000/3200°K, driver escluso. Cod. **500** (L=520mm, 700Lm), cod. **1000** (L=1020mm, 1400Lm) oppure cod. **1500** (L=1520mm, 2100Lm) **made in italy.**

*20 x 14,5mm aluminium profile, complete with diffuser, end caps and 2 fixing brackets, power supply at 24V, 120 LED for meter 3000/3200°K, driver excluded. Code **500** (L=520mm, 700Lm) or code **1000** (L=1020mm, 1400Lm) or code **1500** (L=1520mm, 2100Lm) **made in italy.***

W2 1320.0112.500.-- 92 94 98 10W

W2 1320.0112.1000.-- 92 94 98 20W

W2 1320.0112.1500.-- 92 94 98 30W

W4 cod. 1320.0112.*L*.2700.-- per 2700°K
W2 cod. 1320.0112.*L*.4000.-- per 4000°K

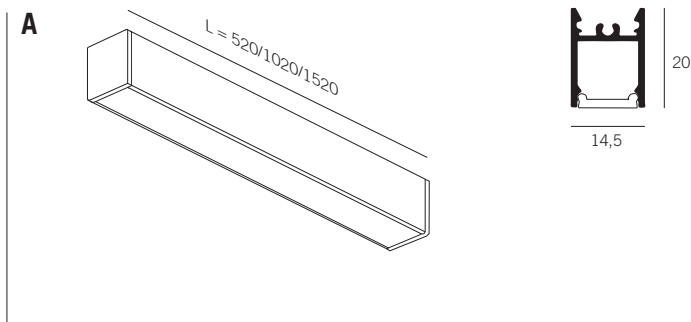

codice di finitura / finishing code:

- 94** bianco superopaco
white ultramatte
- 92** nero superopaco
black ultramatte
- 98** alluminio anodizzato
anodized aluminium



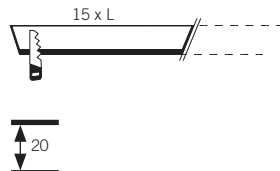
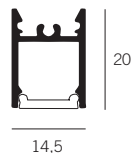
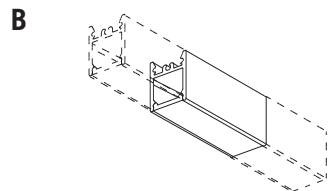

Peso / Weight 0,22 kg/m

B.MT1_12, SYSTEM



Profilo alluminio 20 x 14,5mm L=max 3 mt, completo di diffusore, alimentazione a 24V, 120 LED per metro a 3000/3200°K tagliato a misura, driver escluso. Cod. **120** (Divisibile per multipli di 5 cm, 9,6W/mt, 600 Lm/m) oppure cod. **240** (Divisibile per multipli di 5 cm, 19,2W/mt, 1400 Lm/m **made in italy**).
 20 x 14,5mm aluminium profile L=max 3 mt, complete with diffuser, 24V, 120 LED for meter 3000/3200°K cut on measure, driver excluded. Code **120** (Divisible every 5 cm, 9,6W/mt, 600 Lm/m) or code **240** (Divisible every 5 cm, 19,2W/mt, 1400 Lm/m **made in italy**).

testata di chiusura (1pz)
end cap (1pc)

WI

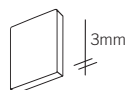

1320.5112.92
1320.5112.94
1320.5112.98



molle per ancoraggio a plafone
fixing springs for surface mounting

WI

1 staffa di ancoraggio ogni mt + 1 (minimo 2 pezzi).
1 bracket every mt + 1 (minimum 2 pcs).

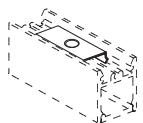

1320.1112

molle per giunzione lineare
linear connection springs

WI

Per profili superiori ai 3 mt ordinare 1 giunto ogni multiplo di 3 mt.
For profiles with length over 3 mt, please order 1 joint every 3 mt.

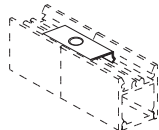

1320.1112

W2 1320.0112.120.-- 92 94 98 9,6W/mt

W2 1320.0112.240.-- 92 94 98 19,2W/mt

W4 cod. 1320.0112.240.2700.-- per 2700°K
W2 cod. 1320.0112.240.4000.-- per 4000°K

EMPTY CUSTOM-MADE



Profilo alluminio 20 x 14,5mm L=max 3 mt, completo di diffusore, tagliato a misura, driver e strip LED esclusi.
20 x 14,5mm aluminium profile L=max 3 mt, complete with diffuser, cut on measure, driver and strip LED excluded.

WI 1320.0112.00.-- 92 94 98

taglio ad angolo
corner's cut

WI

orizzontale 90° / horizontal 90°

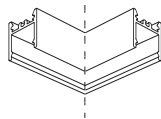

1320.2112

taglio ad angolo
corner's cut

WI

verticale 90° / vertical 90°

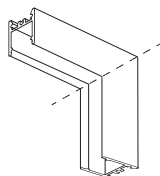

1320.3112

EMPTY STANDARD



Profilo alluminio 20 x 14,5mm, in barre da 3 metri senza taglio a misura completo di diffusore, driver e strip LED esclusi.
20 x 14,5mm aluminium profile, not cut on measure in 3 mt length profile, complete with diffuser, driver and strip LED excluded.

WI 1320.0112.01.-- 92 94 98

staffa di ancoraggio ad incasso
brackets for recessed use

WI

1 staffa di ancoraggio ogni mt + 1 (minimo 2 pezzi).
1 bracket every mt + 1 (minimum 2 pcs).

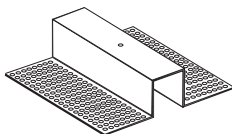

1320.7112

diffusore a perdere per stuccatura
waste diffuser for plastering

WI

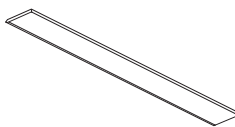

1320.0112.02

ATTENZIONE: applicabile solo con cartongesso standard spessore 12mm.
ATTENTION: applicable only with standard 12mm plasterboard.

driver standard - 24V
standard driver - 24V

WI

15W	1.024015
20W	1.024020
30W	1.024030
50W	1.024050
75W	1.024075
100W	1.97393
150W	1.97759
200W	1.97745

driver dimmerabile PUSH - 24V
dimnable driver PUSH - 24V

WI

22W	1.122264
120W	1.122730

driver dimmerabile DALI - 24V
dimnable driver DALI - 24V

WI

22W	1.122264
120W	1.122730
+ synchron. cable	1.485720512
DALI interface	1.122099

driver dimmerabile IR - 24V
dimnable driver IR - 24V

WI

22W	1.122264
120W	1.122730
+ synchron. cable	1.425720016
receiver IR	1.122093
remote control	1.150120

driver dimmerabile 1...10V - 24V
dimnable driver 1...10V - 24V

WI

120W	1.122730
------	----------

INSTALLAZIONE VERSIONE CON KIT A SCOMPARSITA TOTALE
INSTALLING VERSION WITH TRIMLESS KIT

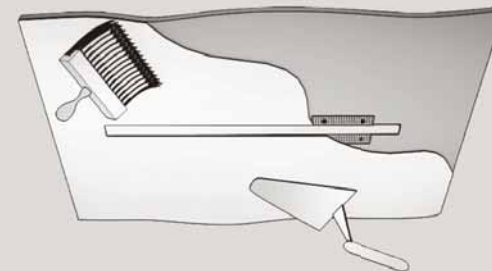
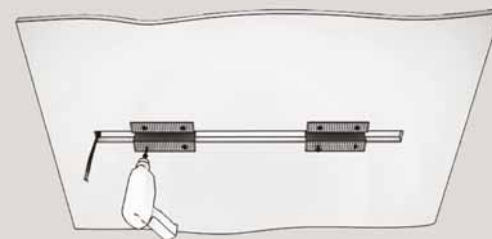

- 1 Predisporre il foro nel cartongesso, fissare le staffe da sotto con le viti per cartongesso in dotazione; agganciare il profilo, stuccare, rasare e pitturare.
Prepare the hole in the plasterboard, fix the brackets from below with the supplied screws; hook the profile, plaster and paint.