

# Neon Flex Pro Top view



Lyskilde	LED
Effekt	10W / 11W pr. m (RGB)
Fargetemperatur	2700K / 3000 / 4000K / RGB
Ra-index	> 90
Lumen	550lm / 540lm / 570lm (LM/m)
Driftspenning	24V
Beskyttelsesgrad	IP67
McAdams	< 3
Farger	Hvit
Dimbar	DALI eller Triac
Forventet levetid	50.000 timer
Lengder	17 meter og 13 meter (RGB) 30cm tilkobling



- Høy lystransmisjon, miljøbeskyttende silikonmateriale, integret ekstruderingsprosess.
- Unikt design av optisk lysfordelingsstruktur, jevn belysningsflate og ingen skygge.
- IP67 beskyttelsesnivå.
- Utmerket fleksibilitet, enkelt og stilig utseende, delikat og unik

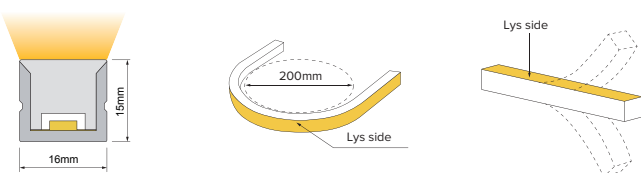
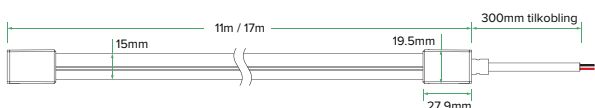

Monteringsanvisning neste side >>>



Vare nr.	Fargetemp	Lumen	Lengde
NF-09-8023-20-927-10-180	2700K	550lm	17 m
NF-09-8024-20-930-10-180	3000K	540lm	17 m
NF-09-8025-20-940-10-180	4000K	570lm	17 m
NF-09-8026-20-RGB-10-180	RGB		13 m

Tilbehør varenr.

- AC-NF Top View 2pin Conector Cable 3m (NB: Inntil 100w driver)
- AC-NF Top View 4pin RGB Conector Cable 3m (NB: Inntil 100w driver)
- AC-NF Top View End Cap
- AC-NF Top View Mount Track 1m Alu
- AC-NF Top View Mount Clips Alu
- AC-NF Top View bottom Conector Cable 3m
- AC-NF Top View side Conector Cable 3m
- AC-NF Cutting Tool

Top View Mount Clips Alu

Top-Side Connector Cable

Top-Bottom Connector Cable

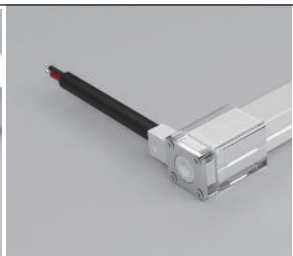

## Monteringsløsninger



Alu monterings klips  
20x16.8x12.5mm(L x W x H)

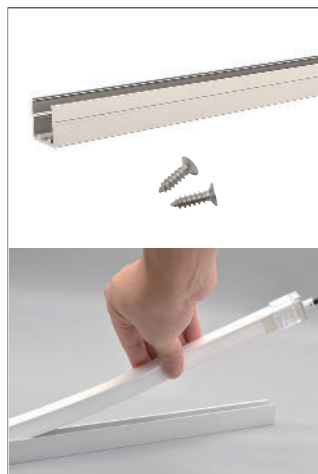

Top View Mount Track 1m Alu  
1000x20x17.5mm(L x W x H)



Pendel vaier

## Installasjonsanvisning av endestykket

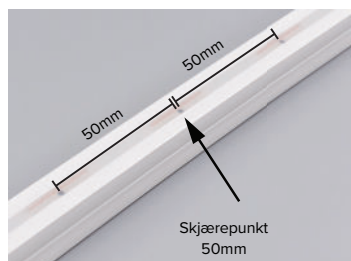

NB: Bunnen av ledestripen har et gjennomsiktig vindu, den svarte markøren er skjærepunktet.



Bruk en Neon Flex saks for et nøyaktig kutt.

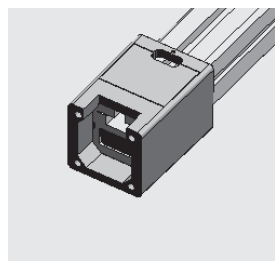
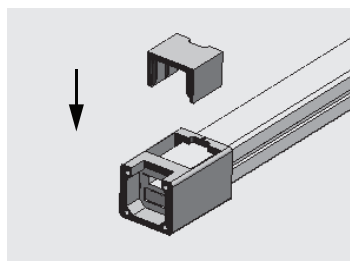
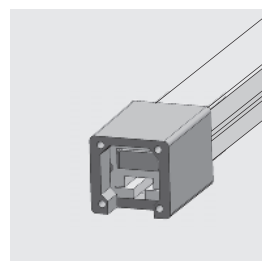
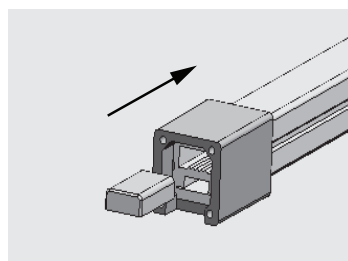
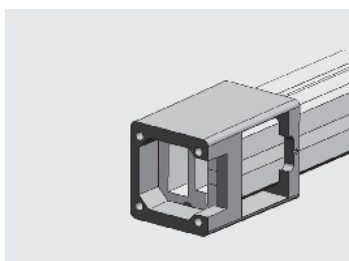
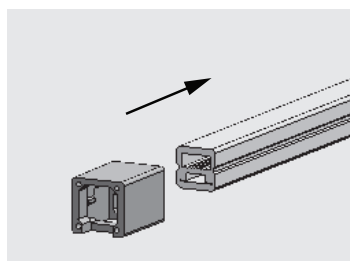
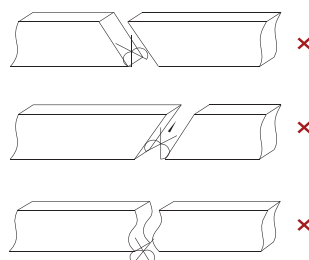

## Monteringsanvisning av strømkabel

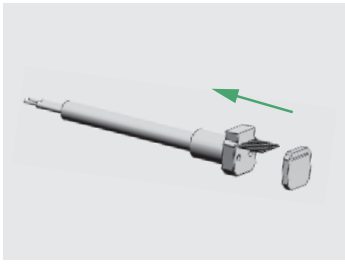

Sett den vanntette pakningen inn i pluggen

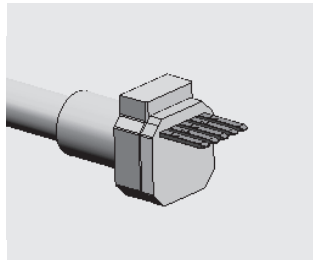

Ferdig koblet med pakning

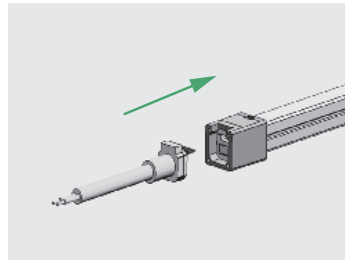

Sett pluggen med den vanntette pakningen inn i ledstripen, og "Pin"-innsatsen mellom FPC og gjennomsiktig PET.

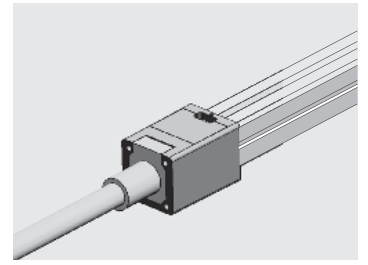

Pluggen ferdig montert

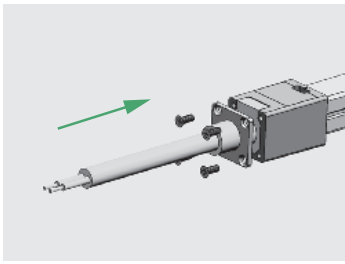

Fest braketten på PC-skallet med 4 stk skruer, på PC-skallet.

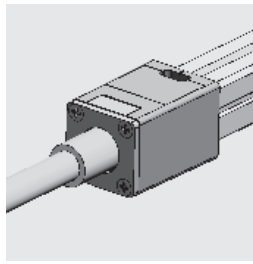

Ferdig montert.

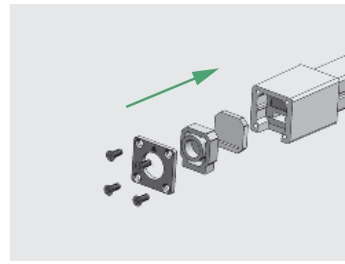

Endestykke diagram

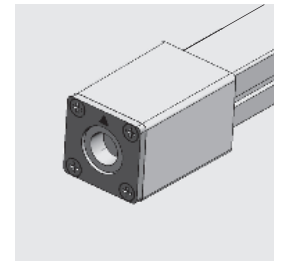

Ferdig montert med endestykke og brakett



# Enkelt tilkoblingskjema

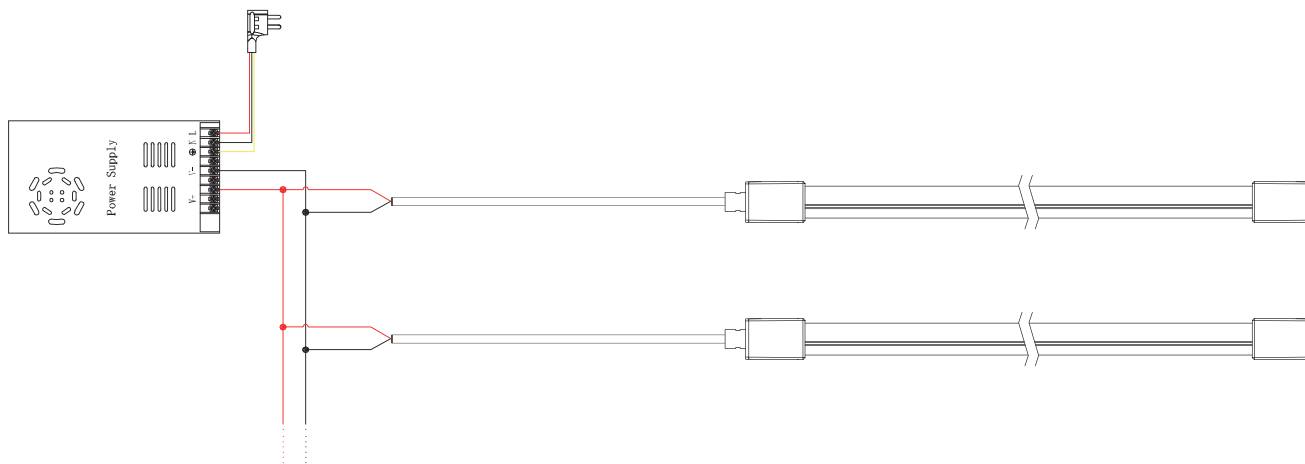

# RGB monterings Diagram

