

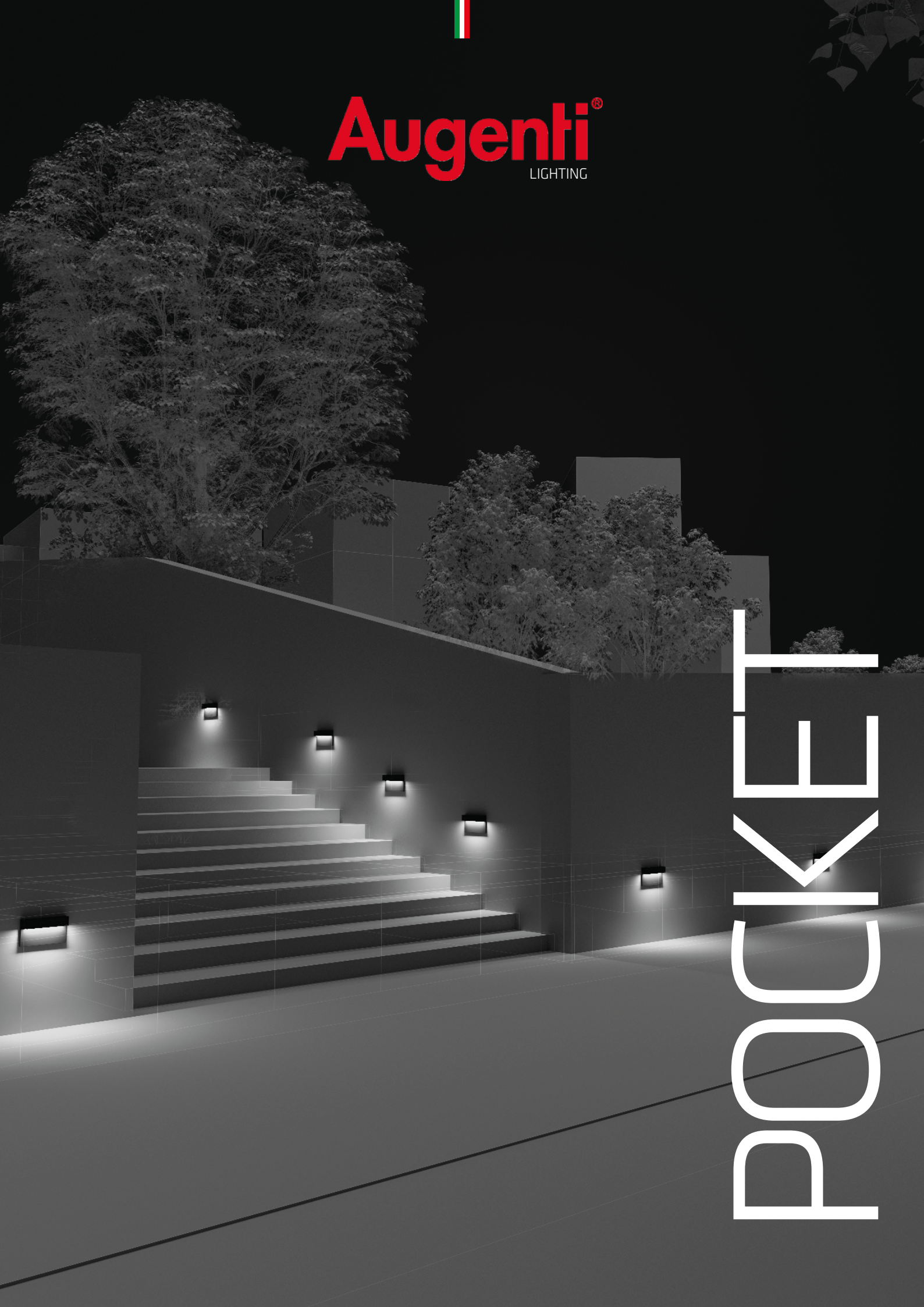



Augenti[®]
LIGHTING



POCKET



IN THE
REALM OF
DREAMS,
LIGHT IS THE
STORYTELLER

POCKET collection

POCKET collection

Pocket, la nuova linea di segnapasso per esterno, è stato concepito con un occhio attento alla cura del dettaglio. Riconosciamo che ogni spazio è unico, motivo per cui Pocket è disponibile in tre dimensioni diverse: sia che si tratti di illuminare un giardino, un vialetto o un percorso pedonale, la nostra gamma soddisfa tutte le esigenze. La sua forma compatta non compromette la sua efficacia. Oltre alla sua **estetica accattivante**, la nostra linea di segnapasso offre **funzionalità avanzate** per migliorare la vostra esperienza all'aperto. Può essere agevolmente fissato alla comune scatola di derivazione elettrica o installato in superficie.

Pocket, the new outdoor step light line, has been conceived with an eye to detail. We recognize that each space is unique, which is why **Pocket** is available in three different sizes: whether it is lighting a garden, a driveway or a pedestrian path, our range meets all needs. Its compact shape does not compromise its effectiveness. In addition to its **eye-catching aesthetic**, our line of step light offers **advanced features** to enhance your outdoor experience. It can be easily fixed to the traditional electrical junction box or installed on the surface.

Pocket, la nouvelle ligne d'encastres muraux pour extérieur, a été conçue avec un souci du détail. Nous reconnaissons que chaque espace est unique, c'est pourquoi **Pocket** est disponible en trois tailles différentes: qu'il s'agisse d'éclairer un jardin, une allée ou un sentier piétonnier, notre gamme répond à tous les besoins. Sa forme compacte ne compromet pas son efficacité. En plus de son **esthétique attrayante**, notre ligne encastrée offre des **fonctionnalités avancées** pour améliorer votre expérience de plein air. Il peut être facilement fixé à la boîte de jonction électrique traditionnelle ou installé en surface.

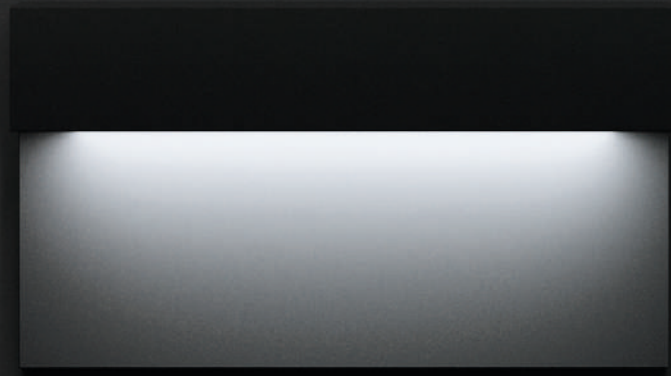

POCKET

collection

Augenti®

3/pocket WALL RECESSED

Fixture Specifications

Protection . IP 65 - IK 07

Body . Die-cast aluminium

Screen . Pointed Glass

Seals . Molded silicone gasket UV Resist

Screws . Stainless steel A2

Paint / Finishing . Anti-corrosive UV stabilised polyester powder



Finishes

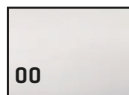

00
PURE WHITE
RAL 9016

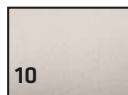

10
WHITE
RAL 9010

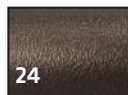

24
BRONZE

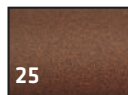

25
RUST

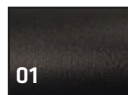

01
BLACK
RAL 9005

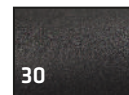

30
ANTHRACITE

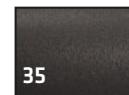

35
SLATE GREY

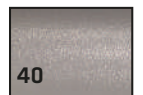

40
GREY
RAL 9006

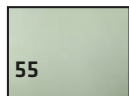

55
GREEN COOL
MINT
RAL 6019

New Color

Technical Data

2700K - 3000K - 4000K

Versione in Tensione - Constant voltage (Vdc)

2W con DRIVER REMOTO 24Vdc - 2W REMOTE DRIVER 24Vdc

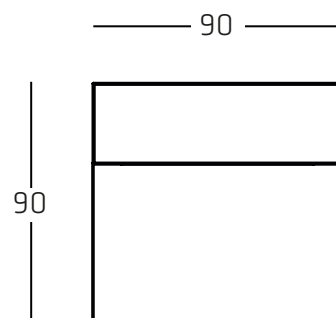
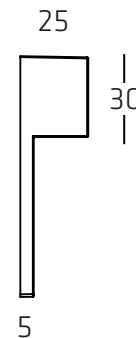

Specifications





POCKET 90

led WHITE

Versione in Tensione - Constant voltage (Vdc)

LED SYSTEM WITH REMOTE DRIVER 24V

code	beam	class	power	W	source	fixture	CCTLED	CRI
9200R /HRRCVT	 DIFFUSE	III	24Vdc	2	280 lm	160 lm	2700K	80
9200R /WRRCVT	 DIFFUSE	III	24Vdc	2	280 lm	160 lm	3000K	80
9200R /NRRCVT	 DIFFUSE	III	24Vdc	2	280 lm	160 lm	4000K	80



Accessories

informazioni sugli accessori sul nostro sito web
information about accessories on our website

Recessed Box 502

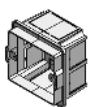

DRIVER 24Vdc

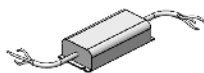

HUB for electronic parts

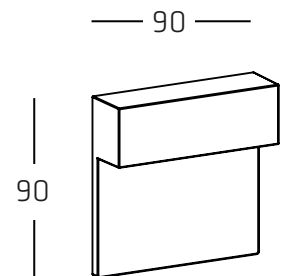
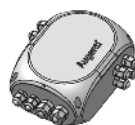

Quote espresse in millimetri "mm"
Share expressed in millimeters "mm"

Sizes . H90 x L90

Specifications



website-link

5/pocket WALL RECESSED

Fixture Specifications

Protection . IP 65 - IK 07

Body . Die-cast aluminium

Screen . Pointed Glass

Seals . Molded silicone gasket UV Resist

Screws . Stainless steel A2

Paint / Finishing . Anti-corrosive UV stabilised polyester powder

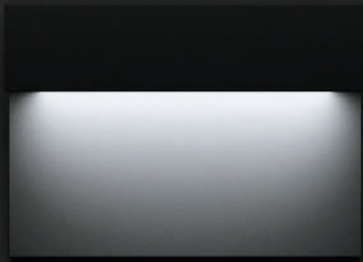

Finishes

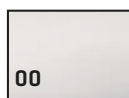

00
PURE WHITE
RAL 9016

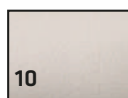

10
WHITE
RAL 9010

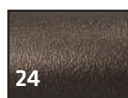

24
BRONZE

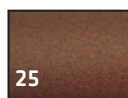

25
RUST

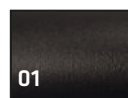

01
BLACK
RAL 9005

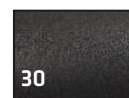

30
ANTHRACITE

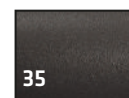

35
SLATE GREY

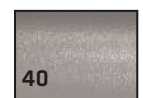

40
GREY
RAL 9006

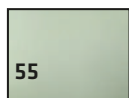

55
GREEN COOL
MINT
RAL 6019

New Color

Technical Data

2700K - 3000K - 4000K

Versione in Tensione - Constant voltage (Vdc)

4W con DRIVER REMOTO 24Vdc - 4W REMOTE DRIVER 24Vdc

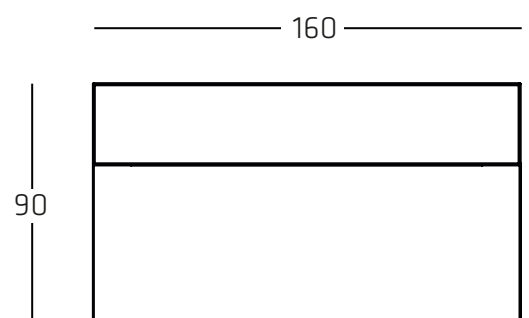
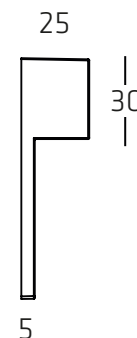

Specifications





POCKET 160

led WHITE

Versione in Tensione - Constant voltage (Vdc)

LED SYSTEM WITH REMOTE DRIVER 24V

code	beam	class	power	W	source	fixture	CCT LED	CRI
9201R /HRRCVT	 DIFFUSE	III	24Vdc	4	560 lm	310 lm	2700K	80
9201R /WRRCVT	 DIFFUSE	III	24Vdc	4	560 lm	310 lm	3000K	80
9201R /NRRCVT	 DIFFUSE	III	24Vdc	4	560 lm	310 lm	4000K	80

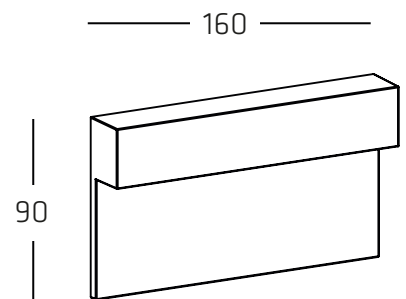
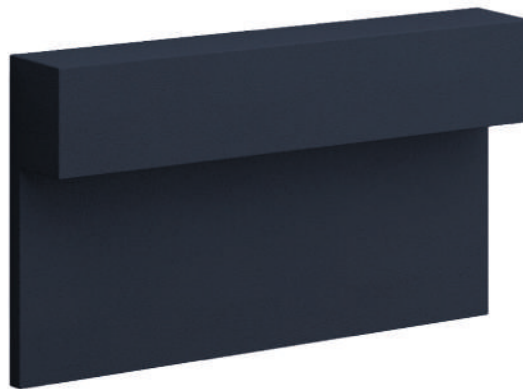

Accessories

informazioni sugli accessori sul nostro sito web
information about accessories on our website

Recessed Box 503/504

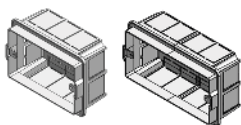

DRIVER 24Vdc

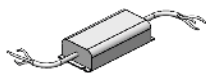

HUB for electronic parts

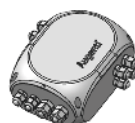

Quote espresse in millimetri "mm"
Share expressed in millimeters "mm"

Sizes . H90 x L160

Specifications



website-link

Fixture Specifications

Protection . IP 65 - IK 07

Body . Die-cast aluminium

Screen . Pointed Glass

Seals . Molded silicone gasket UV Resist

Screws . Stainless steel A2

Paint / Finishing . Anti-corrosive UV stabilised polyester powder

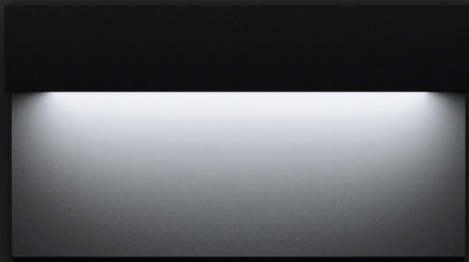

Finishes

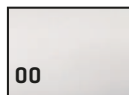

00
PURE WHITE
RAL 9016

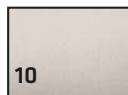

10
WHITE
RAL 9010

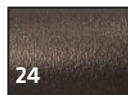

24
BRONZE

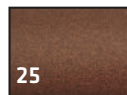

25
RUST

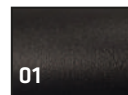

01
BLACK
RAL 9005

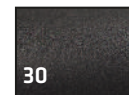

30
ANTHRACITE

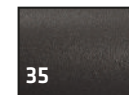

35
SLATE GREY

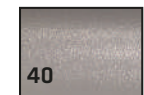

40
GREY
RAL 9006

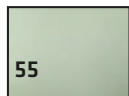

55
GREEN COOL
MINT
RAL 6019

New Color

Technical Data

2700K - 3000K - 4000K

Versione in Tensione - Constant voltage (Vdc)

6W con DRIVER REMOTO 24Vdc - 6W REMOTE DRIVER 24Vdc

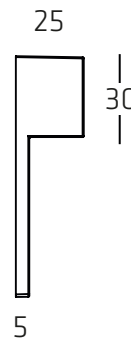

230

90

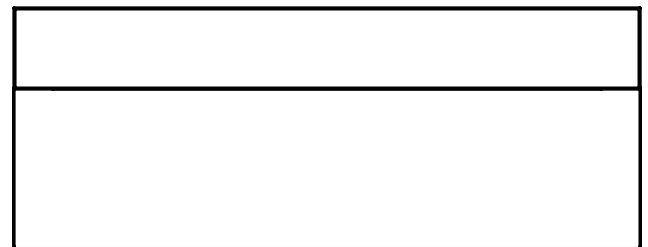

Specifications



POCKET 230

led WHITE

Versione in Tensione - Constant voltage (Vdc)

LED SYSTEM WITH REMOTE DRIVER 24V

code	beam	class	power	W	source	fixture	CCTLED	CRI
9202R /HRRCVT	 DIFFUSE	III	24Vdc	6	840 lm	460 lm	2700K	80
9202R /WRRCVT	 DIFFUSE	III	24Vdc	6	840 lm	460 lm	3000K	80
9202R /NRRCVT	 DIFFUSE	III	24Vdc	6	840 lm	460 lm	4000K	80

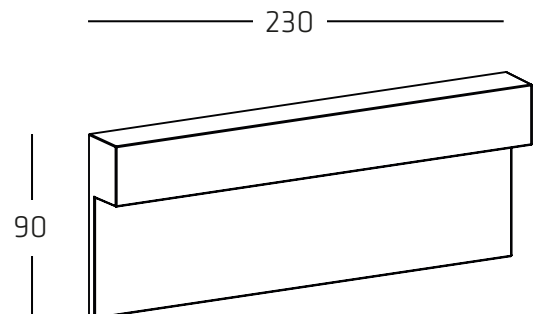
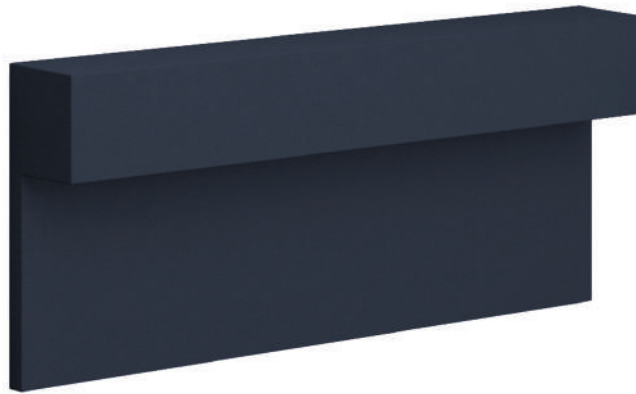

Accessories

informazioni sugli accessori sul nostro sito web
information about accessories on our website

Recessed Box 503/504

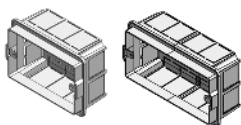

DRIVER 24Vdc

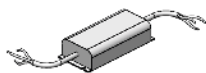

HUB for electronic parts

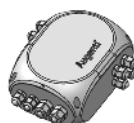

Quote espresse in millimetri "mm"
Share expressed in millimeters "mm"

Sizes . H90 x L230

Specifications



website-link

POCKET light diffusion

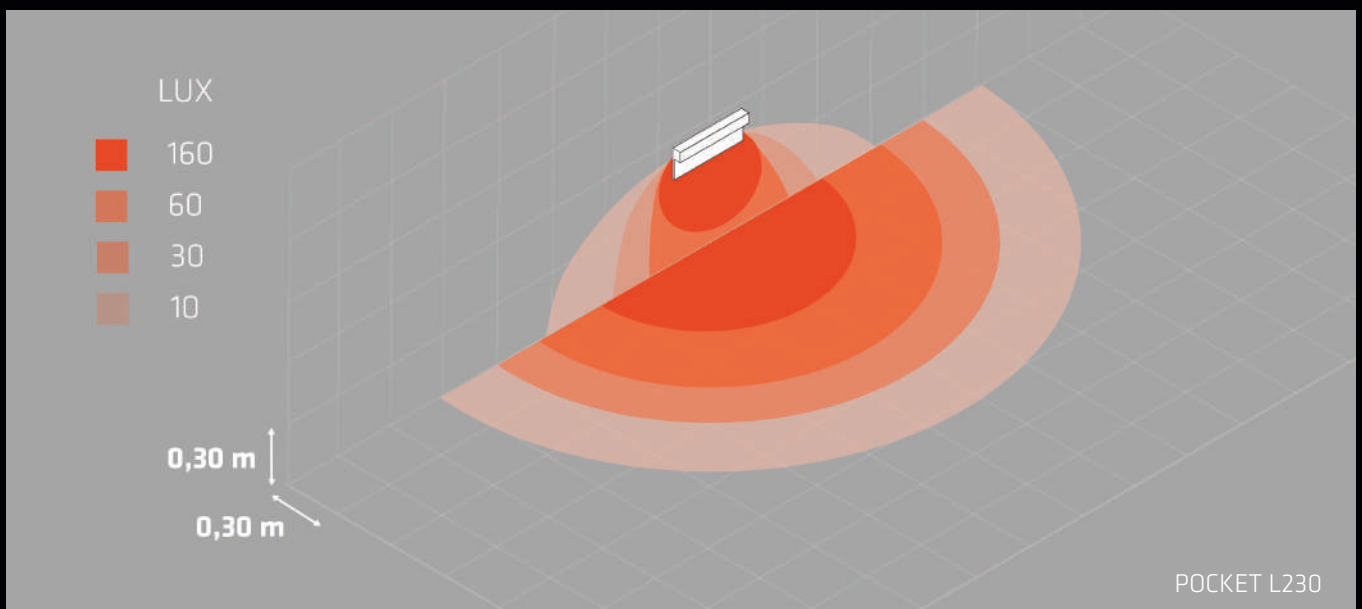
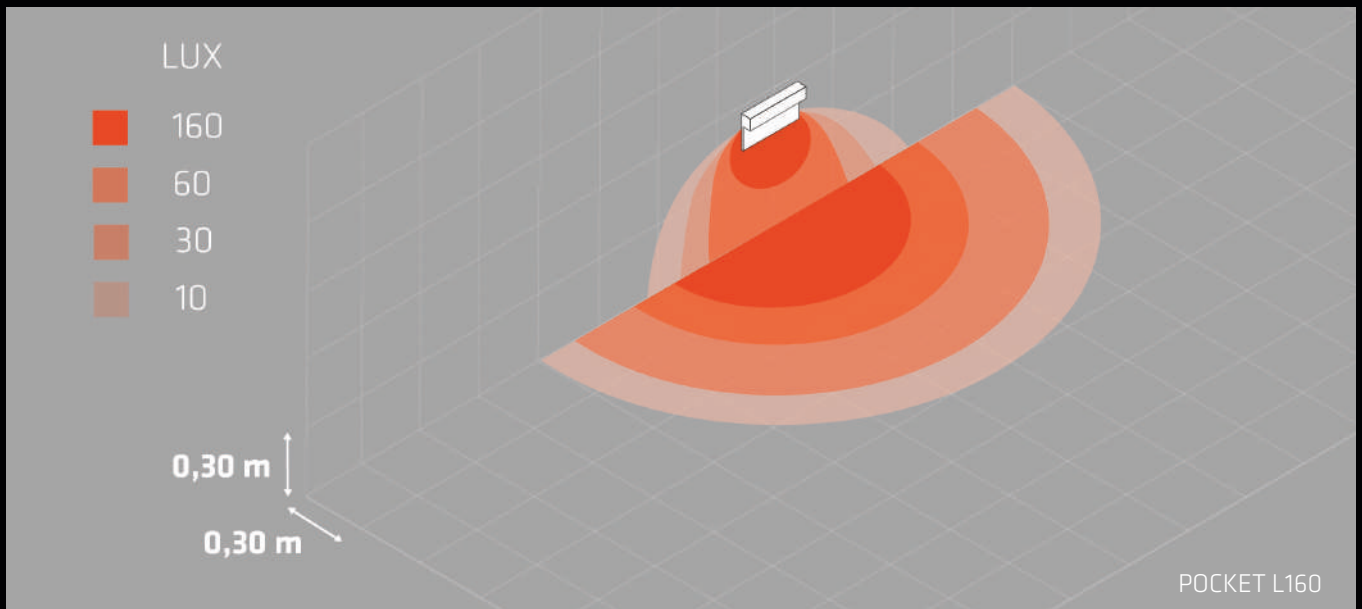
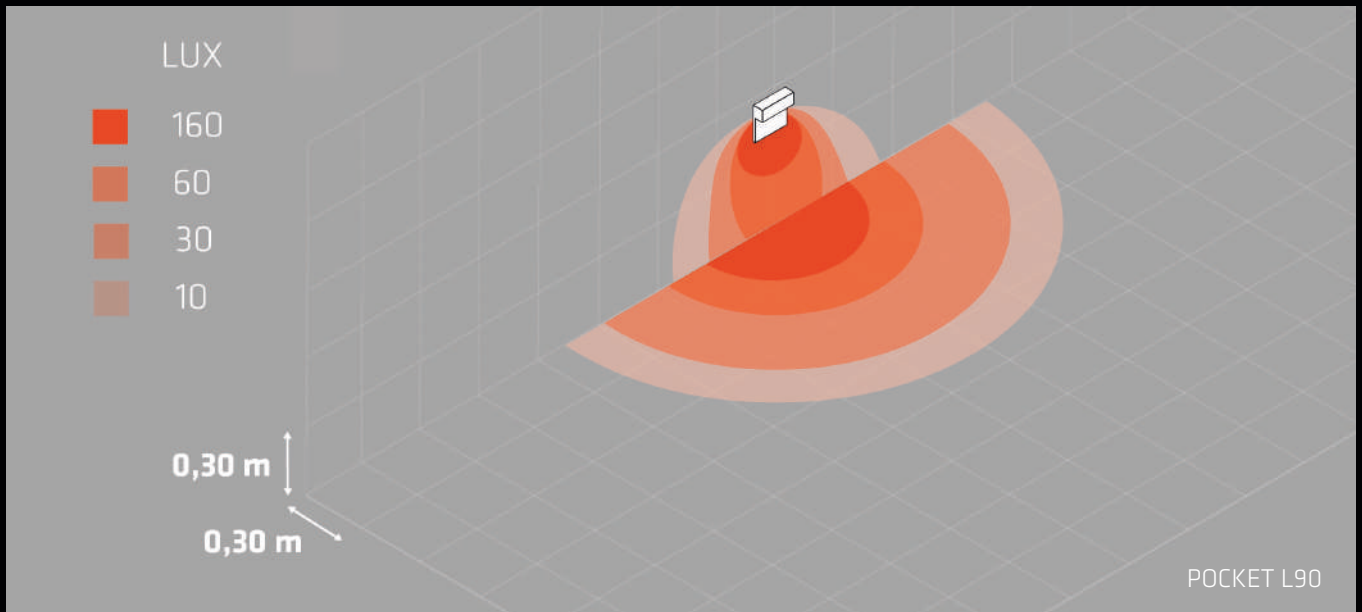

POCKET

collection

Augenti[®]

11/pocket WALL RECESSED

POCKET

collection





Augenti

13/pocket WALL RECESSED

POCKET

GOOD

INSTALLATION

BY **Augenti**[®]
LIGHTING



Augenti[®]

LIGHTING



AUGENTI LIGHTING S.R.L. UNIPERSONALE

Via Francesco Lana, 31 - 25065 Lumezzane (BS) Italy - tel: (+39) 030 7282524 - fax: (+39) 030 7281879
info@augentilighting.it - www.augentilighting.it